

20'

Plan View

10'

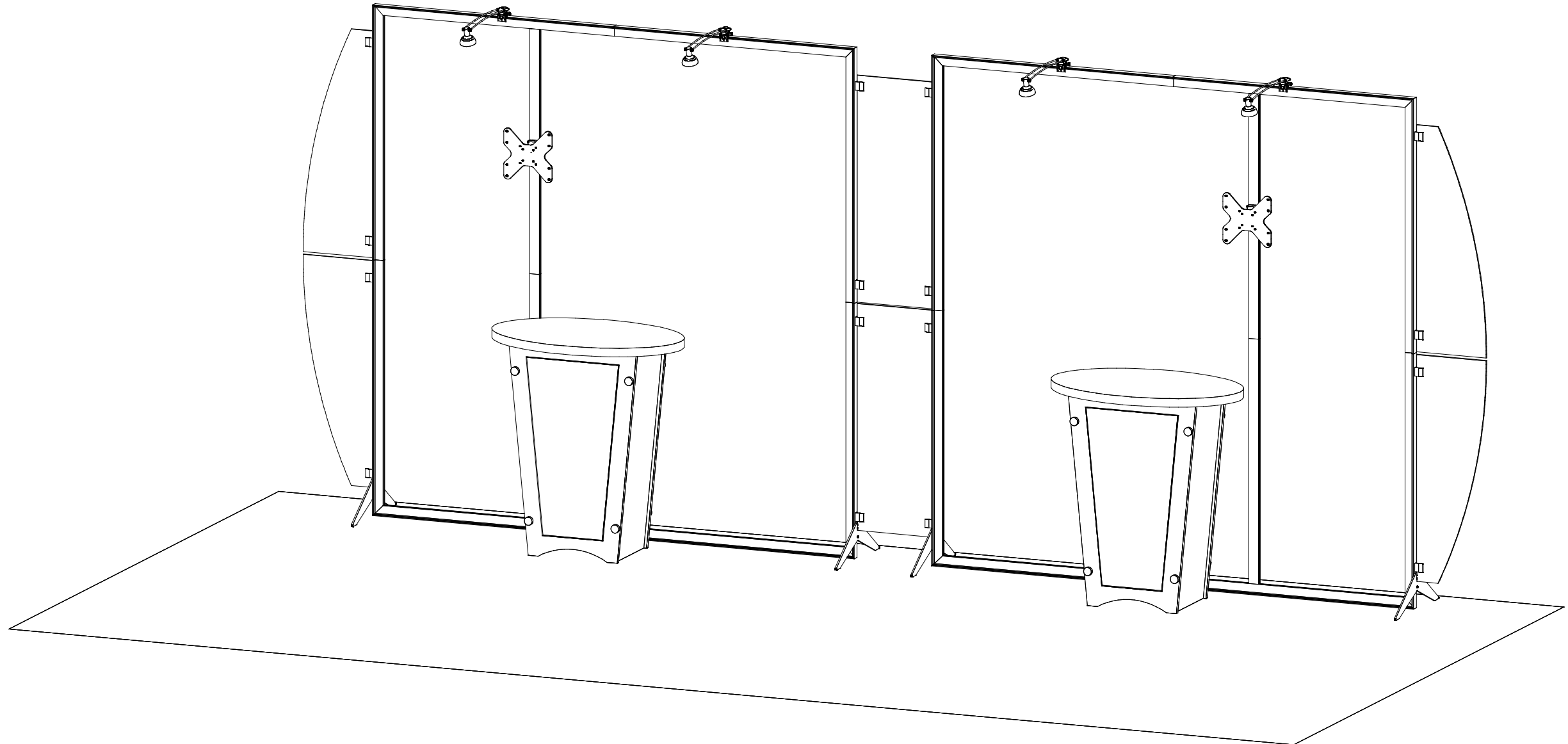

SETUP INSTRUCTIONS

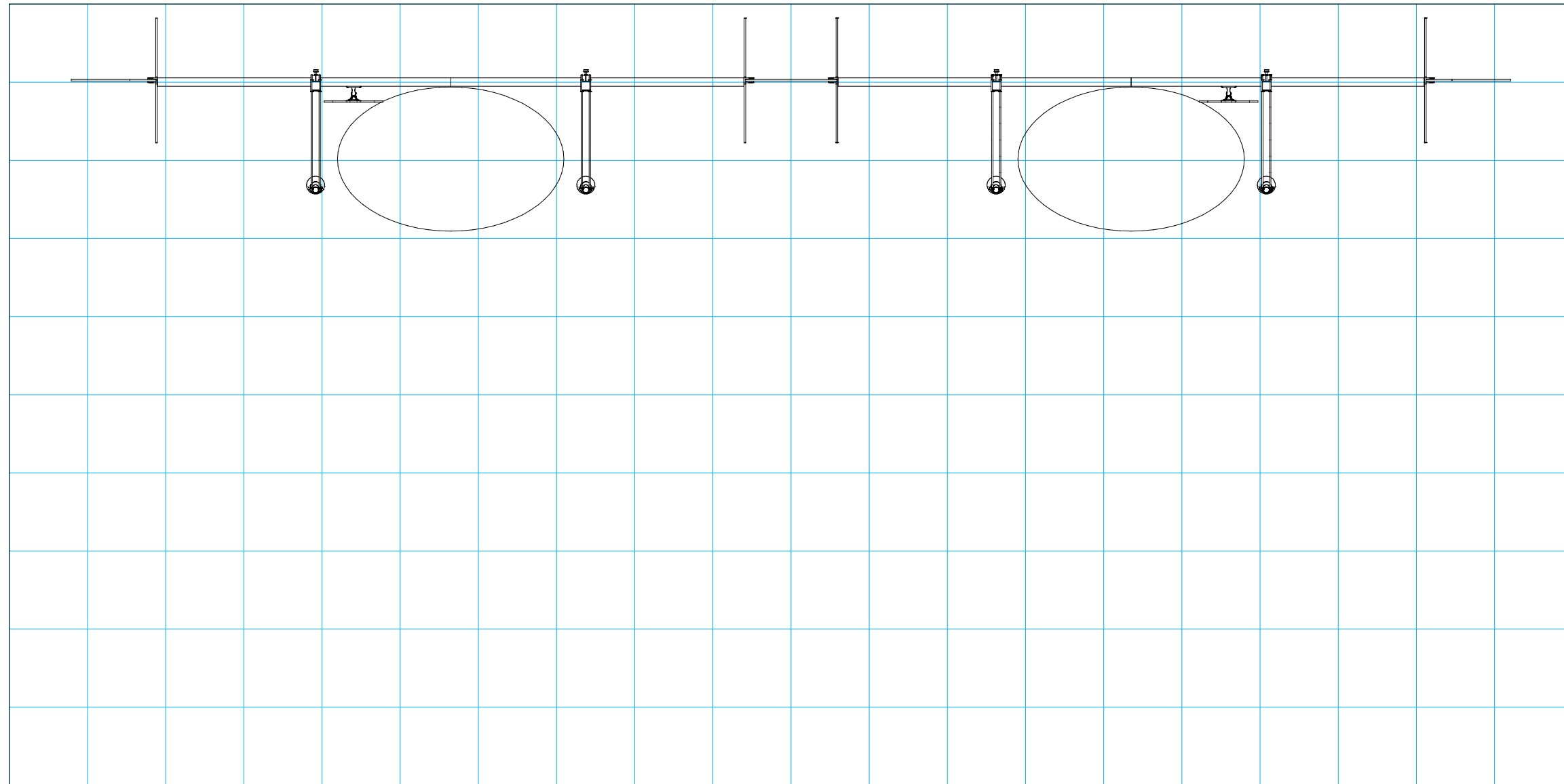

 = 1 sq foot

General Setup Instructions

- Read entire setup instruction manual prior to unpacking parts and pieces.
- The setup instructions are created specifically for this configuration.
- Setup instructions are laid out sequentially in steps, including exploded views with detailed explanation for assembly.

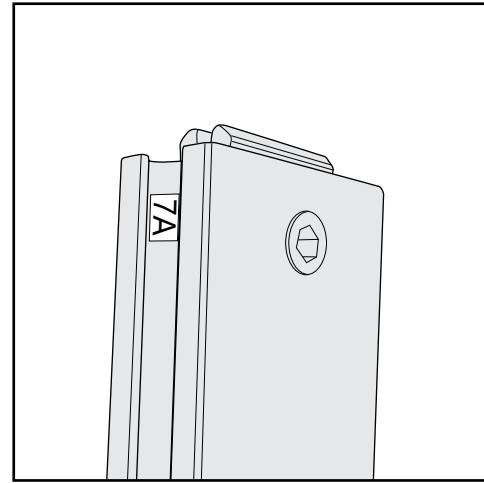

Part Identification - Numbering

Cleaning & Packing

- For Cleaning Metal, Plex, & Laminate Parts: Use a **MILD NON-ABRASIVE** cleanser and soft cloth/paper towel to clean all surfaces.
- Keep exhibit components away from heat and prolonged sun exposure.
Heat and UV exposure will warp and fade components.
- Retain all provided Packing Materials. All provided packing materials are for ease of repacking & component protection.

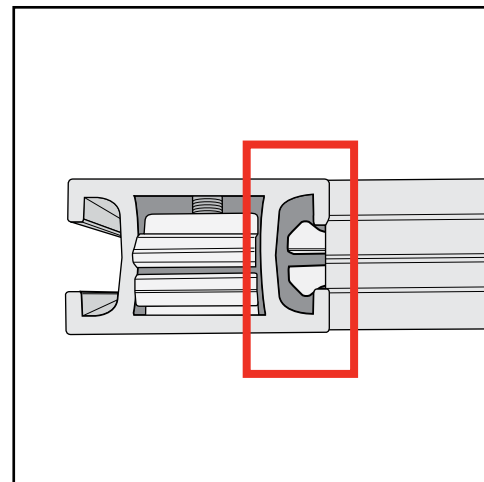

Engaged Lock



WARNING



DO NOT USE POWER TOOLS



ALL CONNECTIONS MUST
BE TIGHTLY SECURED

Disassembly

- For loss prevention, keep all knobs & connectors attached to extrusions during disassembly.

Straight Connection

When assembling frame, first attach all **straight connectors**, then attach **corner connectors**.

- 1) Place extrusions end-to-end.
- 2) Loosen all knobs, then slide **straight connector** across the seam of extrusions.
- 3) Tighten all knobs to secure connection.

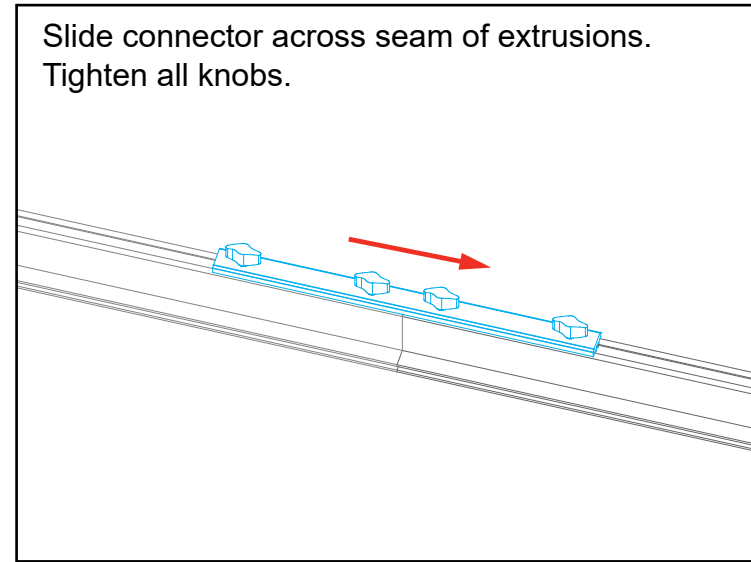
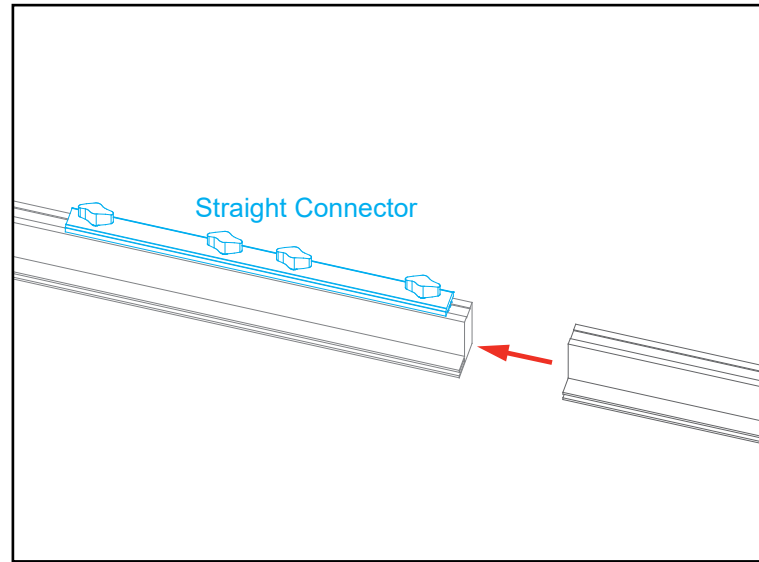

Slide connector across seam of extrusions.
Tighten all knobs.

Disassembly

- 1) Loosen all knobs.
- 2) Slide connectors off of one extrusion.
- 3) Tighten knobs to prevent loss during packing & shipping.

Keep straight connectors in groove of extrusion. Do not remove connectors during disassembly.

All knobs must be tightened securely to ensure a proper connection.

Corner Connection

- 1) Loosen knobs, then slide vertical extrusions onto **corner connectors** of **lower** horizontal extrusion.
- 2) Slide **corner connectors** of **upper** horizontal extrusion into grooves of vertical extrusions.
- 3) Tighten all knobs to secure connection.

Disassembly

- 1) Loosen knobs on vertical extrusions.
- 2) Slide the vertical extrusions off of **corner connectors** on lower and upper horizontal extrusions.

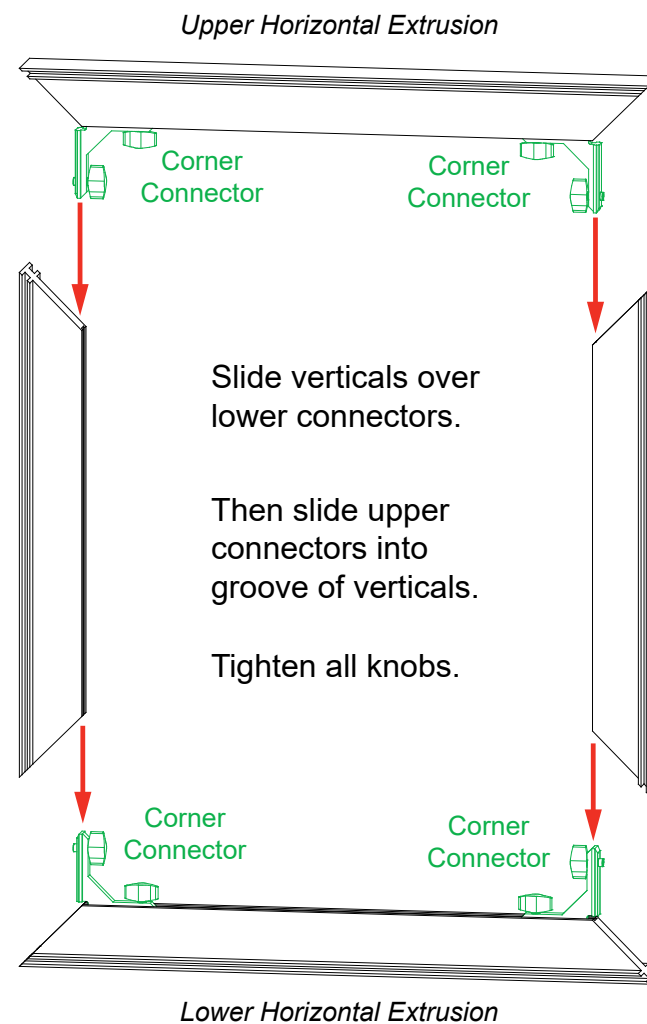

Slide verticals over lower connectors.

Then slide upper connectors into groove of verticals.

Tighten all knobs.



Adjust connectors if necessary to prevent gaps in connection.

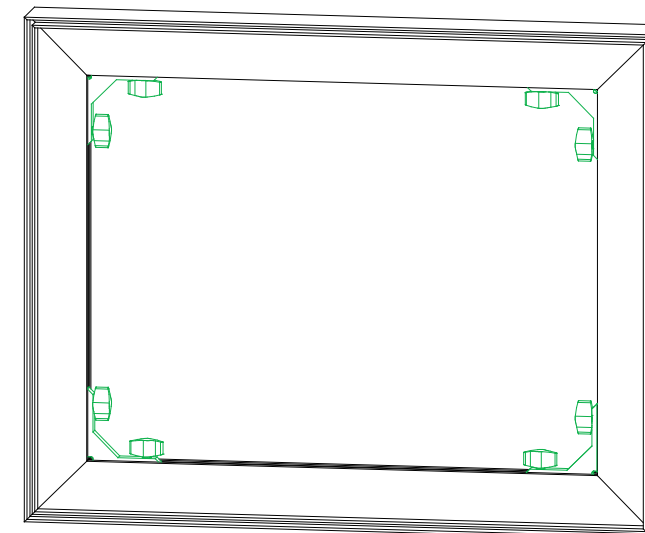

COMPLETED ASSEMBLY

All knobs must be tightened securely to ensure a proper connection.

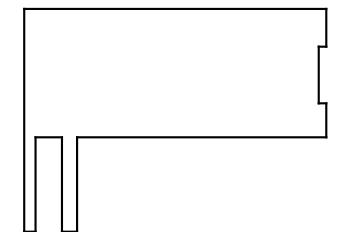

TSP46 Profile

SEG Graphic Installation *in 3 Steps*

The Perfect Fit

STEP 1: Attach Corners

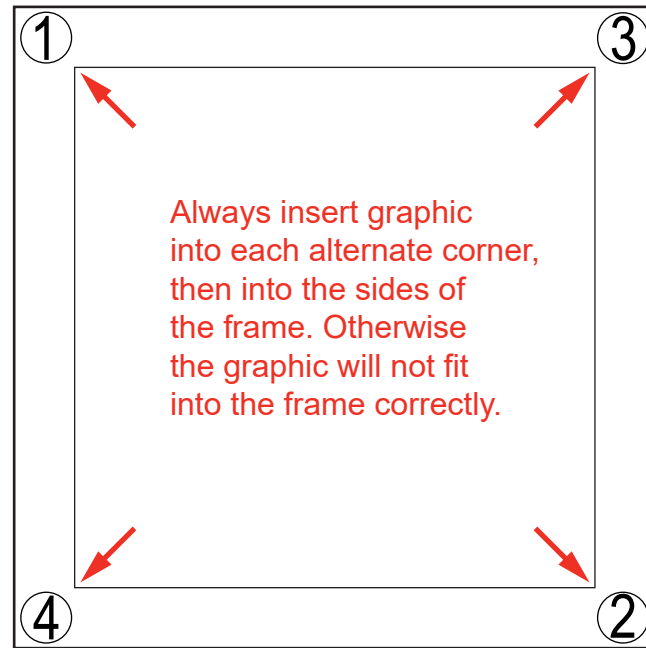

STEP 2: Attach Middle

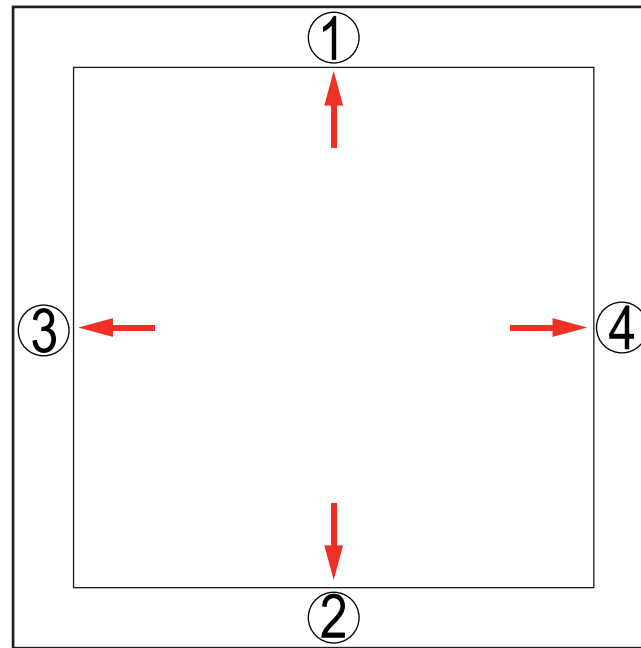

STEP 3: Attach Sides

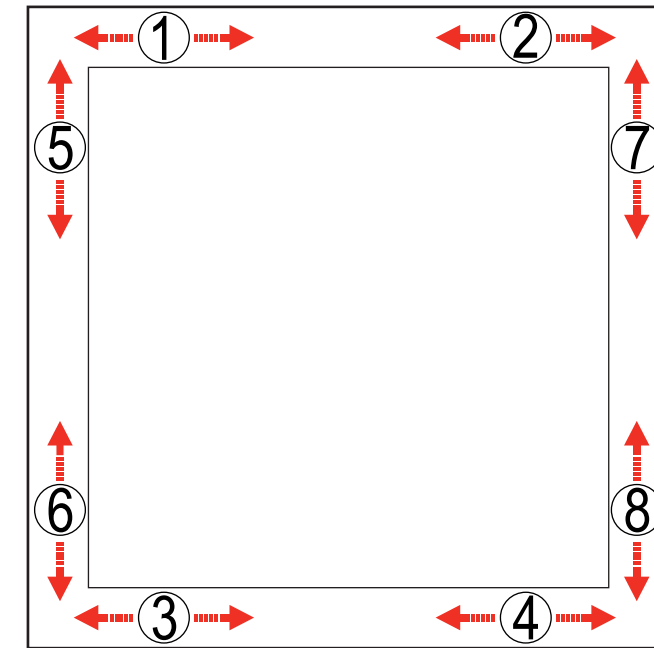

Insert narrow side of silicone welt into the channel at corner 1, with fabric to the outside.

Repeat for opposite corner 2, then corner 3, then corner 4.

Once corners are attached, press the middle of edge 1 into the channel. Then press middle of edge 2 into the channel on opposite side.

Repeat with edge 3 & 4.

Once the middle of sides are attached, fully press the silicone welt into the channel, between center and corner at location 1. Repeat the process between center and corner at location 2.

Do the same for welt on opposite side, at locations 3 & 4. Then repeat for locations 5 & 6 and 7 & 8.

Once the welt is fully inserted on all sides, smooth out edges as needed for a perfect fit.



To remove the graphic from the frame, locate the fabric **pull tab**. Gently pull on the tab to remove the graphic.

Install video:



Top View of Each Level

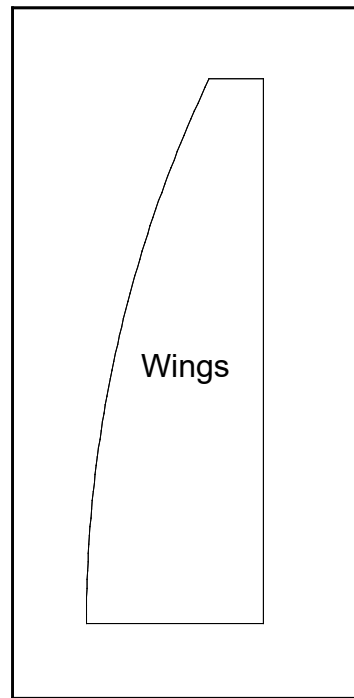

Level 1
(Bottom level)

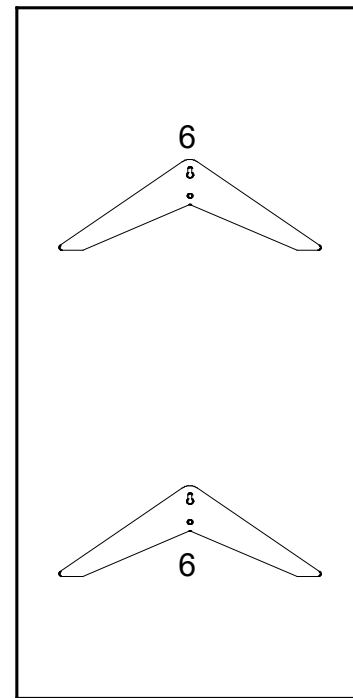

Level 2

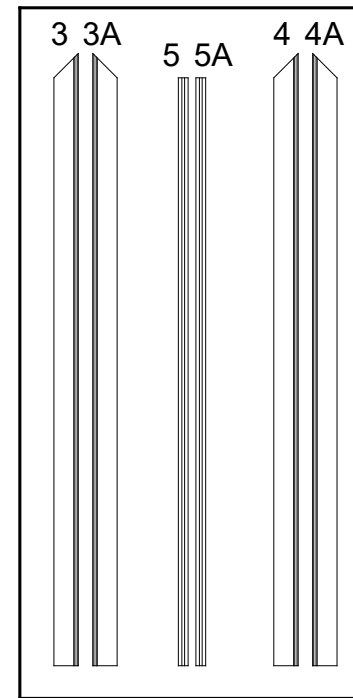

Level 3

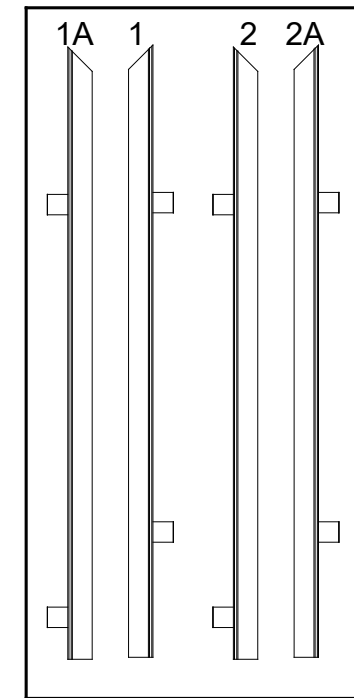

Level 4

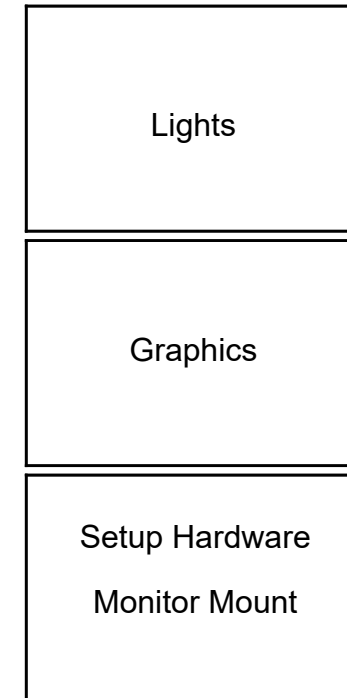

Top View of Each Level

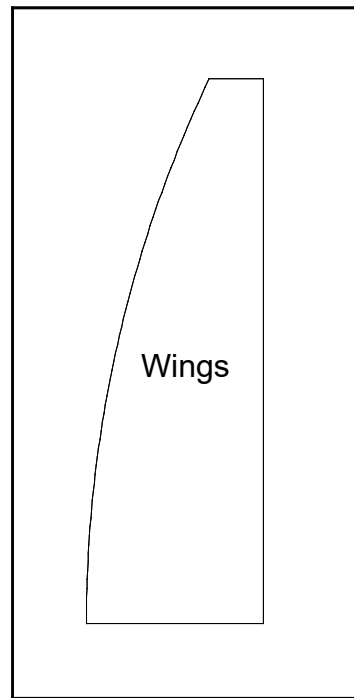

Level 1
(Bottom level)

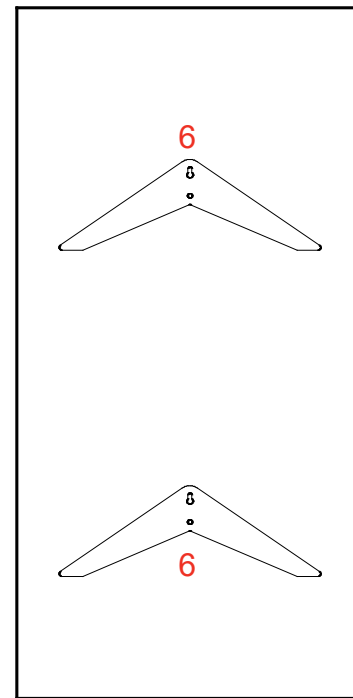

Level 2

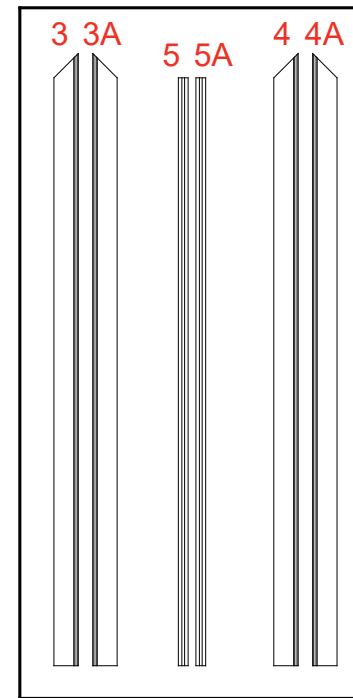

Level 3

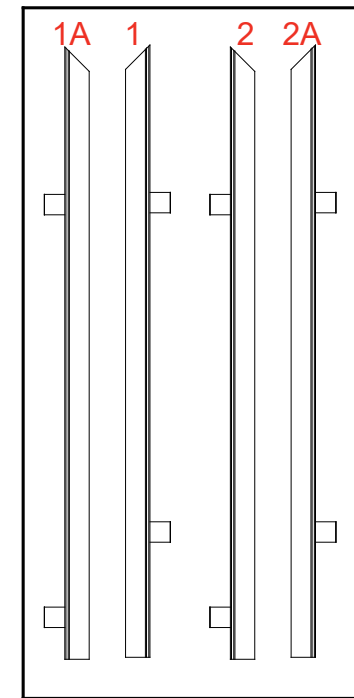

Level 4

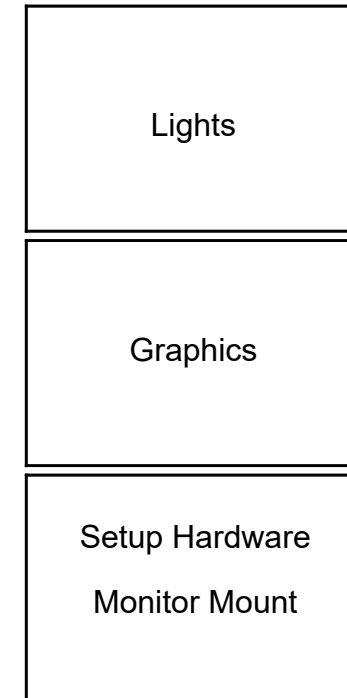

Top View of Each Level

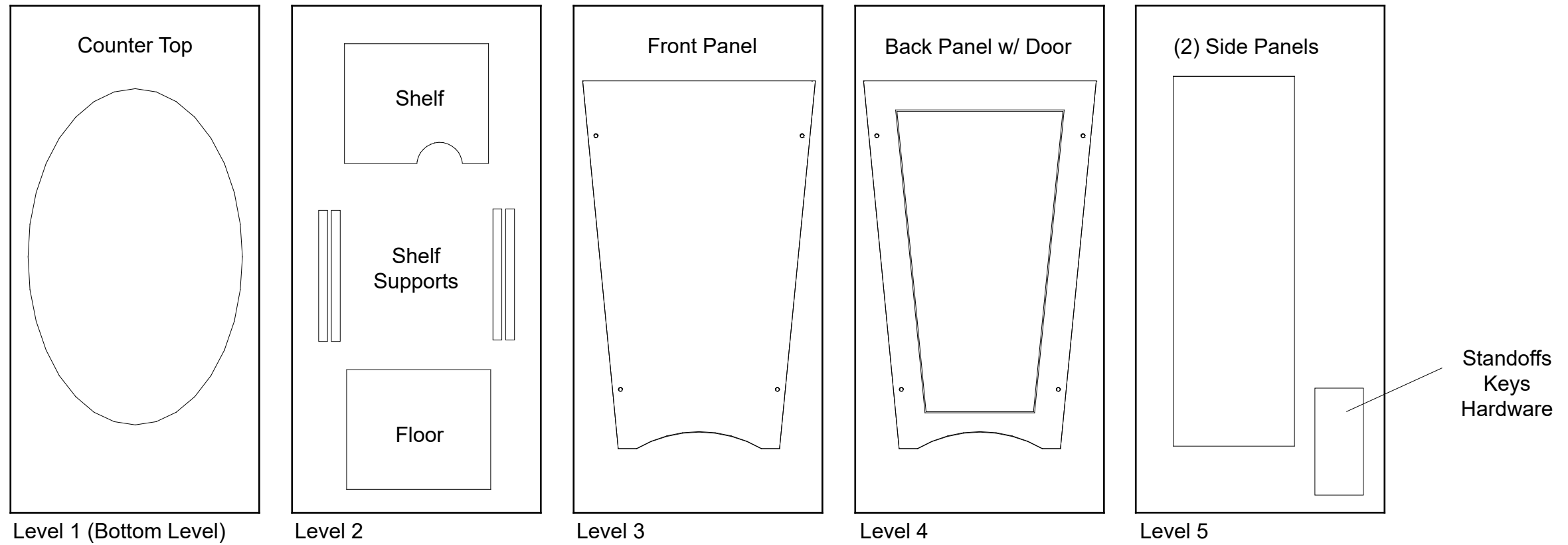

Top View of Each Level

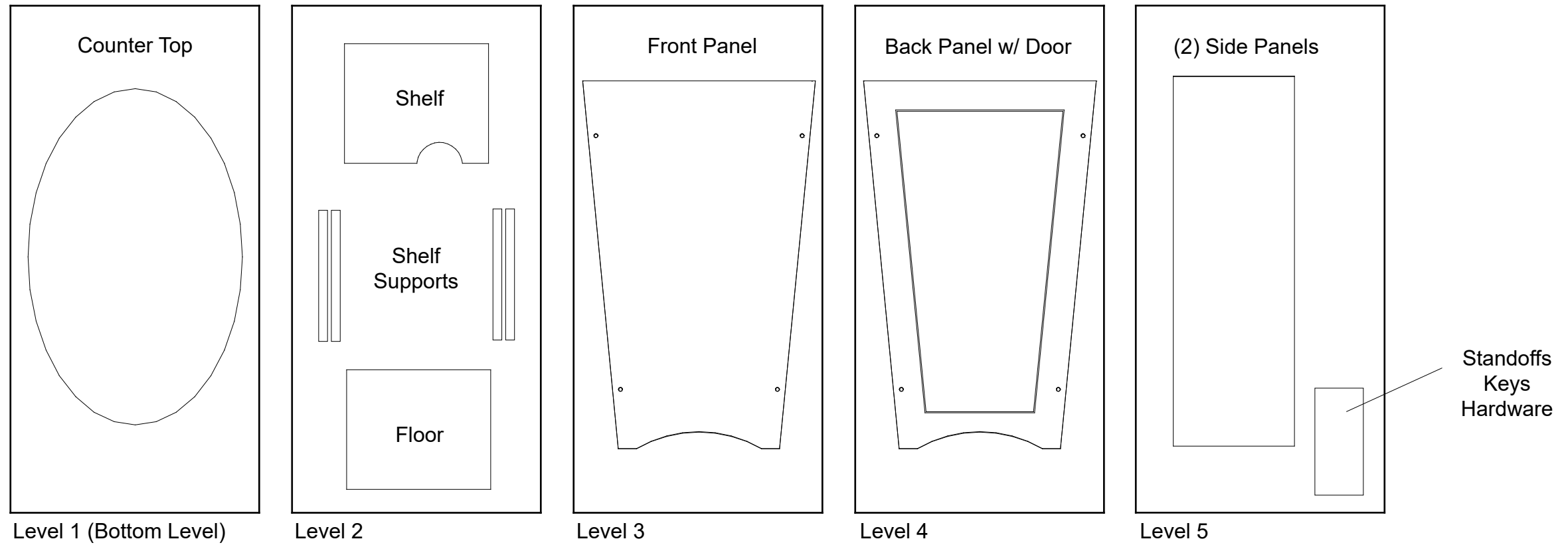

Item	Qty.	Description
1,1A	1,1	45" TSP46 Vertical Extrusion w/ Clamps
2,2A	1,1	45" TSP46 Vertical Extrusion w/ Clamps
3,3A	1,1	45" TSP46 Horizontal Extrusion
4,4A	1,1	45" TSP46 Horizontal Extrusion
5,5A	1,1	43.2085" Z45 Vertical Extrusion
6	2	Boomerang Foot

Assemble frame flat on ground.

Steps:

Refer to the *Tool-less Frame Assembly* general information page.

- 1) Assemble vertical extrusions [1-1A], [2-2A], [5-5A] & horizontal extrusions [3-3A], [4-4A], using **Tool-less Spline connectors** labeled [X].
- 2) Connect vertical assemblies [1/1A], [2/2A] between horizontal assemblies [3/3A], [4/4A], using **Tool-less Corner Connectors** labeled [A].
- 3) Install Boomerang Feet [6] to frame assembly as shown. See **Boomerang Foot Attachment** detail.
- 4) Lift up frame & connect vertical assembly [5/5A] between horizontals as shown. See **Z45 Connection** detail.

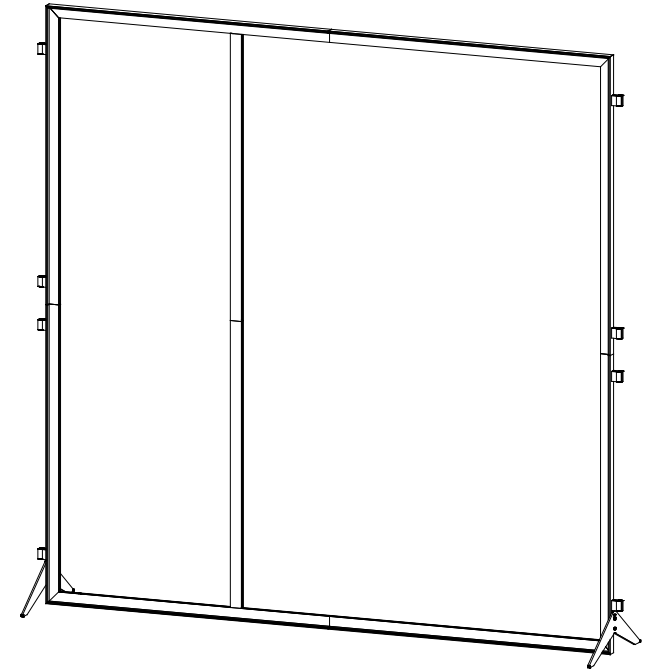

When assembled

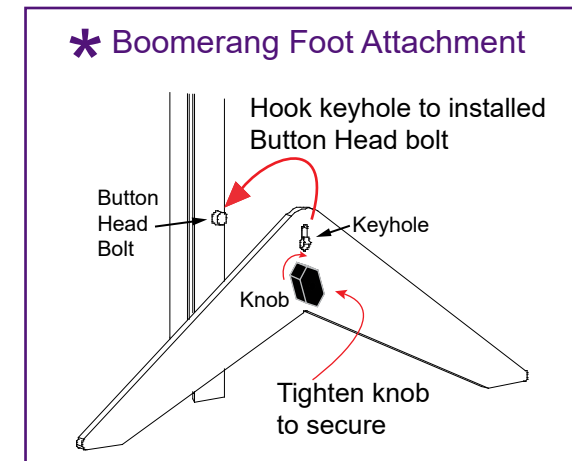
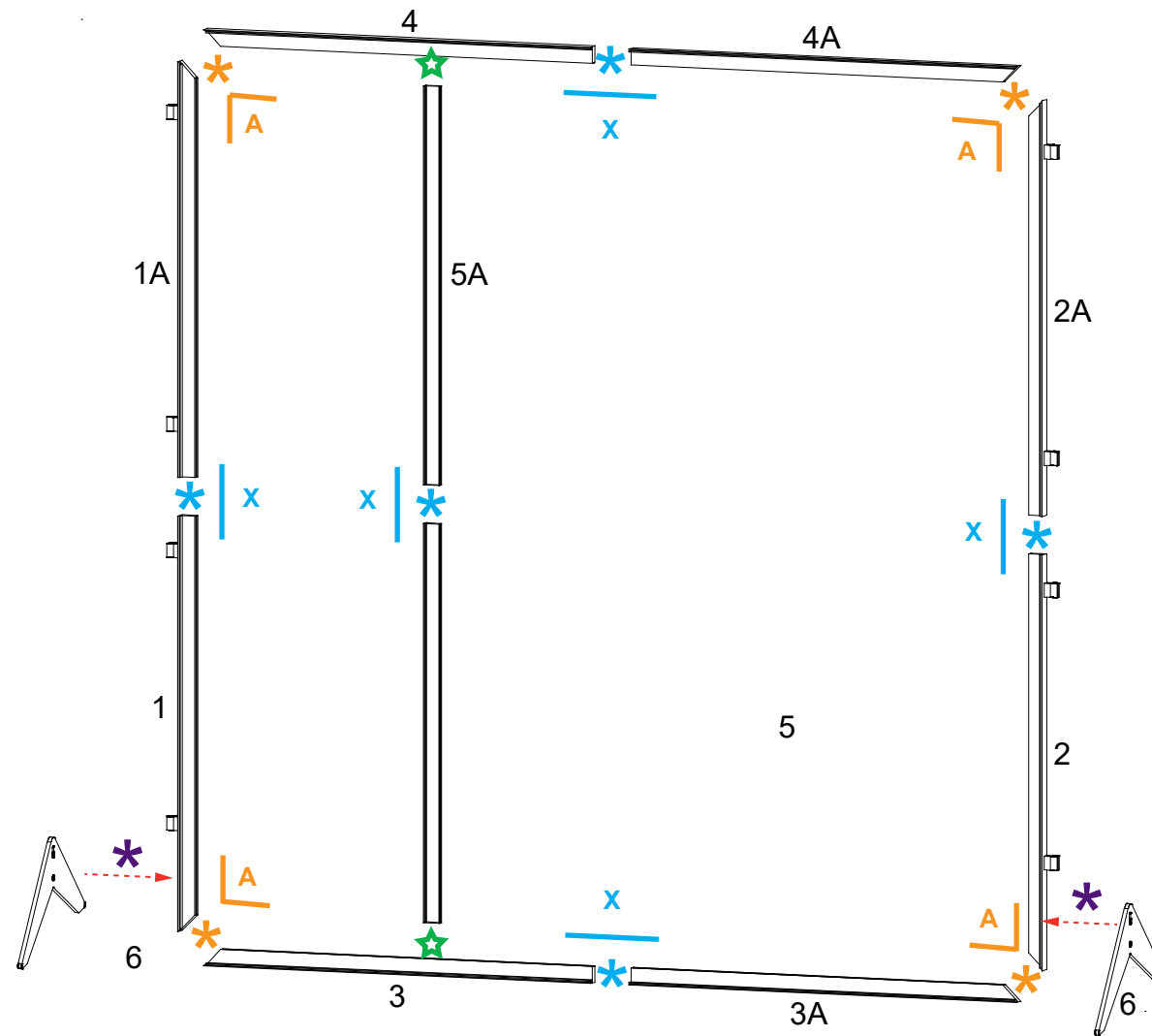
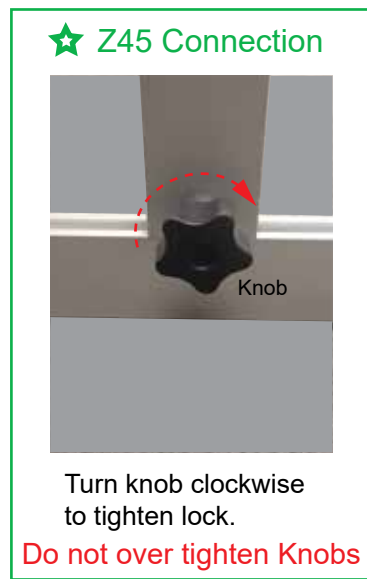

Keep A10 clamps attached to [1] [1A] [2] and [2A], when packing.

Item	Qty.	Description
1,1A	1,1	45" TSP46 Vertical Extrusion w/ Clamps
2,2A	1,1	45" TSP46 Vertical Extrusion w/ Clamps
3,3A	1,1	45" TSP46 Horizontal Extrusion
4,4A	1,1	45" TSP46 Horizontal Extrusion
5,5A	1,1	43.2085" Z45 Vertical Extrusion
6	2	Boomerang Foot

Assemble frame flat on ground.

Steps:

Refer to the *Tool-less Frame Assembly* general information page.

- 1) Assemble vertical extrusions [1-1A], [2-2A], [5-5A] & horizontal extrusions [3-3A], [4-4A], using **Tool-less Spline connectors** labeled [X].
- 2) Connect vertical assemblies [1/1A], [2/2A] between horizontal assemblies [3/3A], [4/4A], using **Tool-less Corner Connectors** labeled [A].
- 3) Install Boomerang Feet [6] to frame assembly as shown. See **Boomerang Foot Attachment** detail.
- 4) Lift up frame & connect vertical assembly [5/5A] between horizontals as shown. See **Z45 Connection** detail.

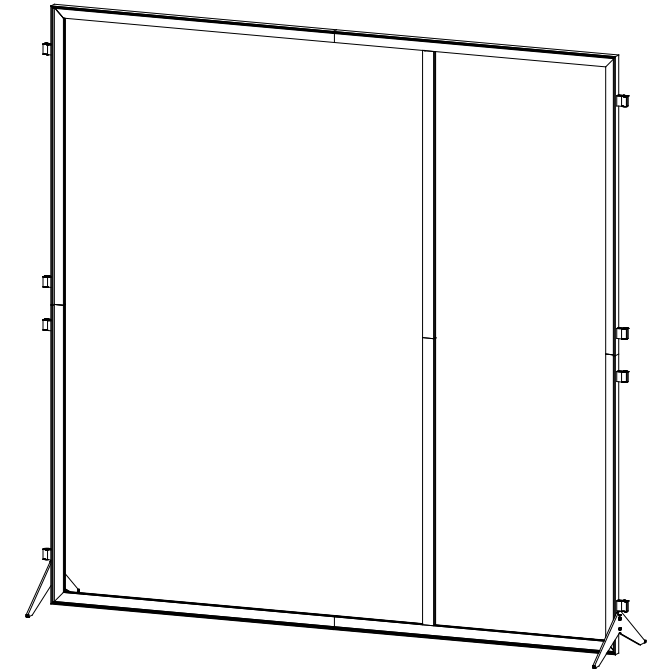

When assembled

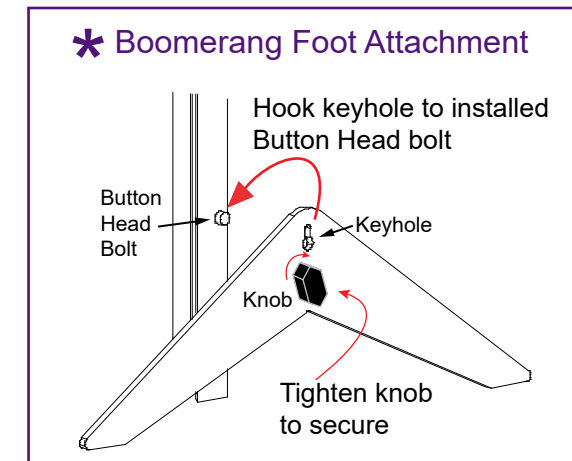
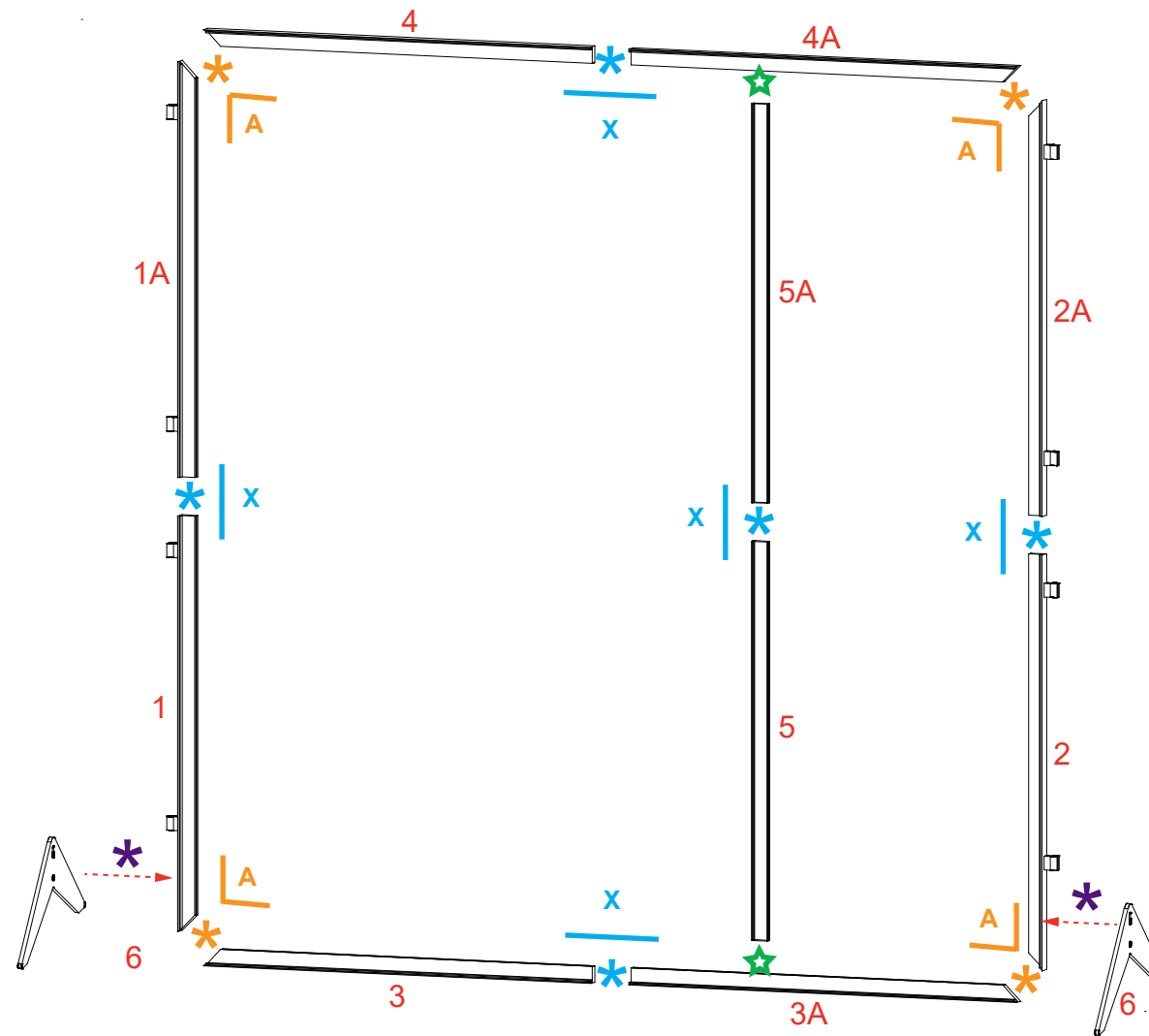
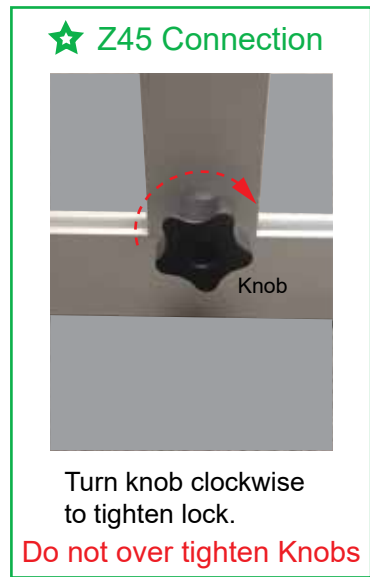

Keep A10 clamps attached to [1] [1A] [2] and [2A], when packing.

Steps:

Refer to the *SEG Installation general information page*.

- 1) Apply SEG graphics to front of frame assemblies.
- 2) Attach wings to clamps, as shown. See [A10 Clamp Attachment](#) detail.
- 3) Attach monitor mounts to [5A] and [5A]. See [Monitor Mount Attachment](#) detail.
- 4) Attach lights to top of assembled frames. See [Light Connection](#) detail.

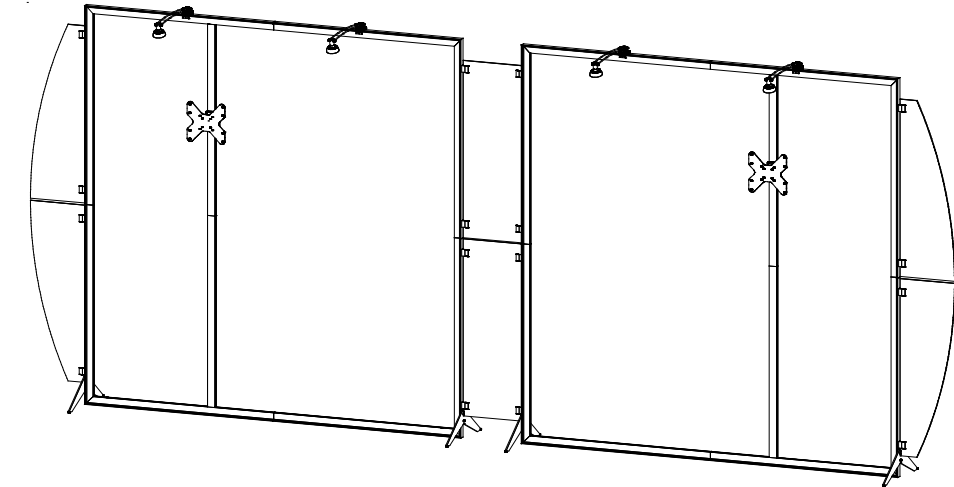

Completed Assembly

* Light Connection

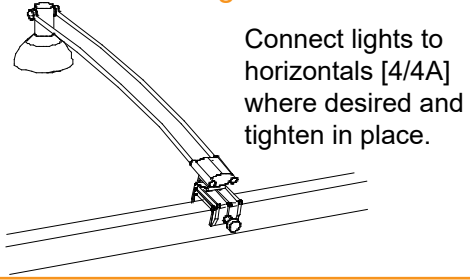

* Monitor Mount Attachment

Attach Monitor Mount back piece to vertical extrusion, using bolts.

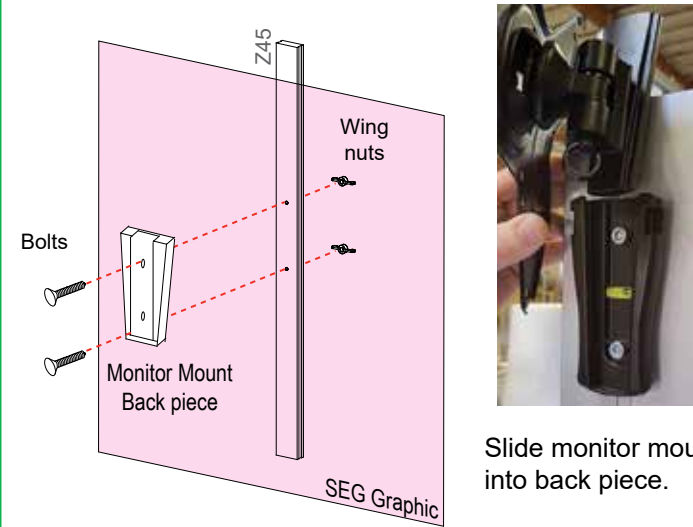

Slide monitor mount into back piece.

Note: Monitor mounts install through SEG graphic.

A10 Clamp Attachment

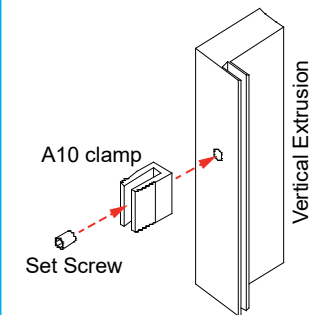

Screw A10 clamp to Vertical Extrusion.

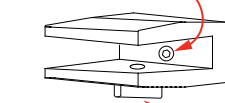

Tighten knob to secure wing in place.

Clamps should NOT be removed. Leave attached when packing.

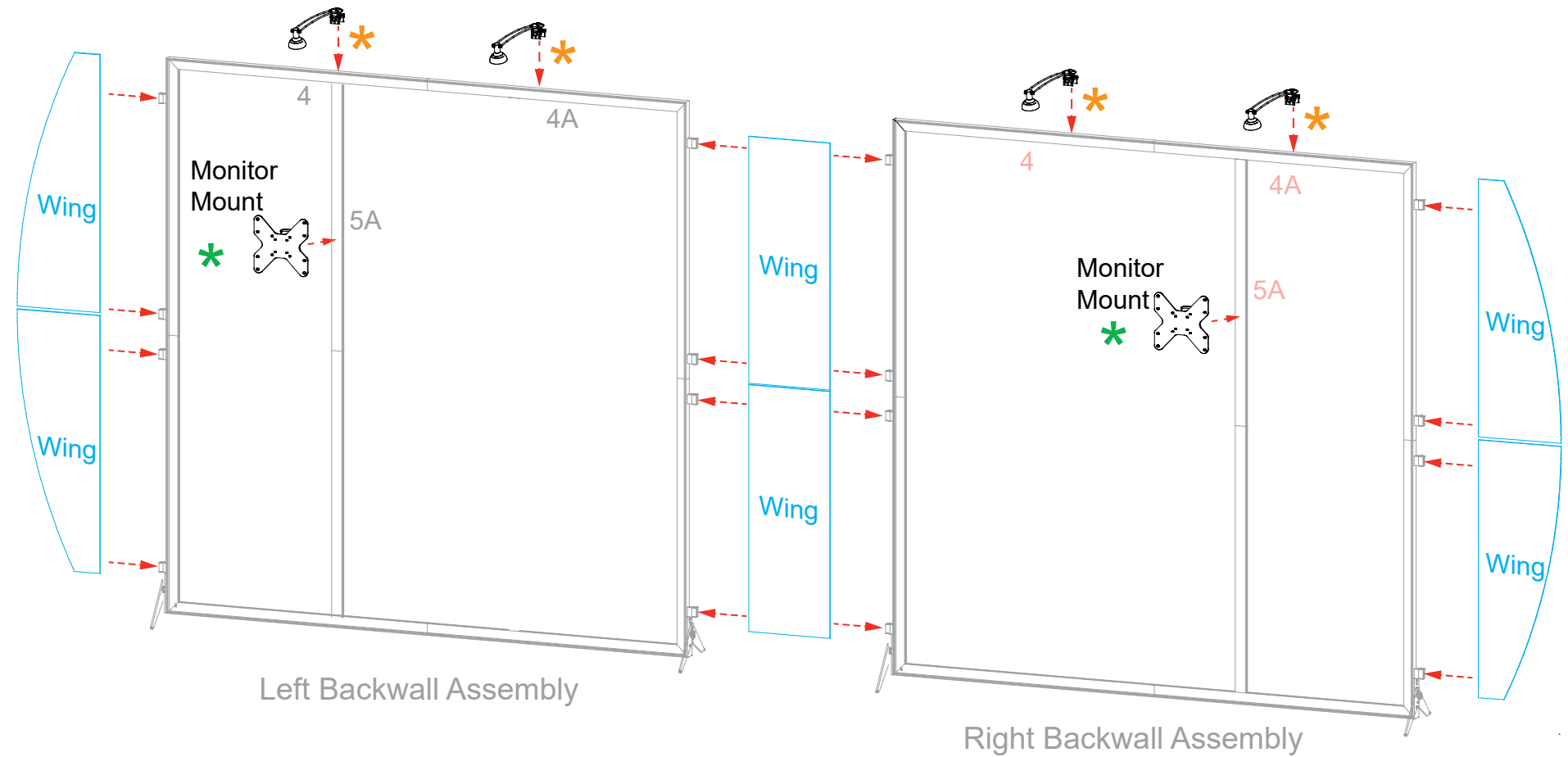

Setup Instructions:

- 1) Attach pins at bottom interior of side panels. *Note: Pins are designed to be slightly angled.*
- 2) Use screw caps to secure the side panels to front panel and back panels, making sure Velcro is facing inward.
- 3) Slide floor into the bottom of assembled pedestal base. The floor will sit on pins of the side panels.
- 4) Connect **shelf supports** to Velcro on panels, then place shelf on top of supports.
- 5) Attach pedestal top to assembled pedestal base. See [Pedestal Top Attachment](#) detail.

Repeat steps for other pedestal assembly.

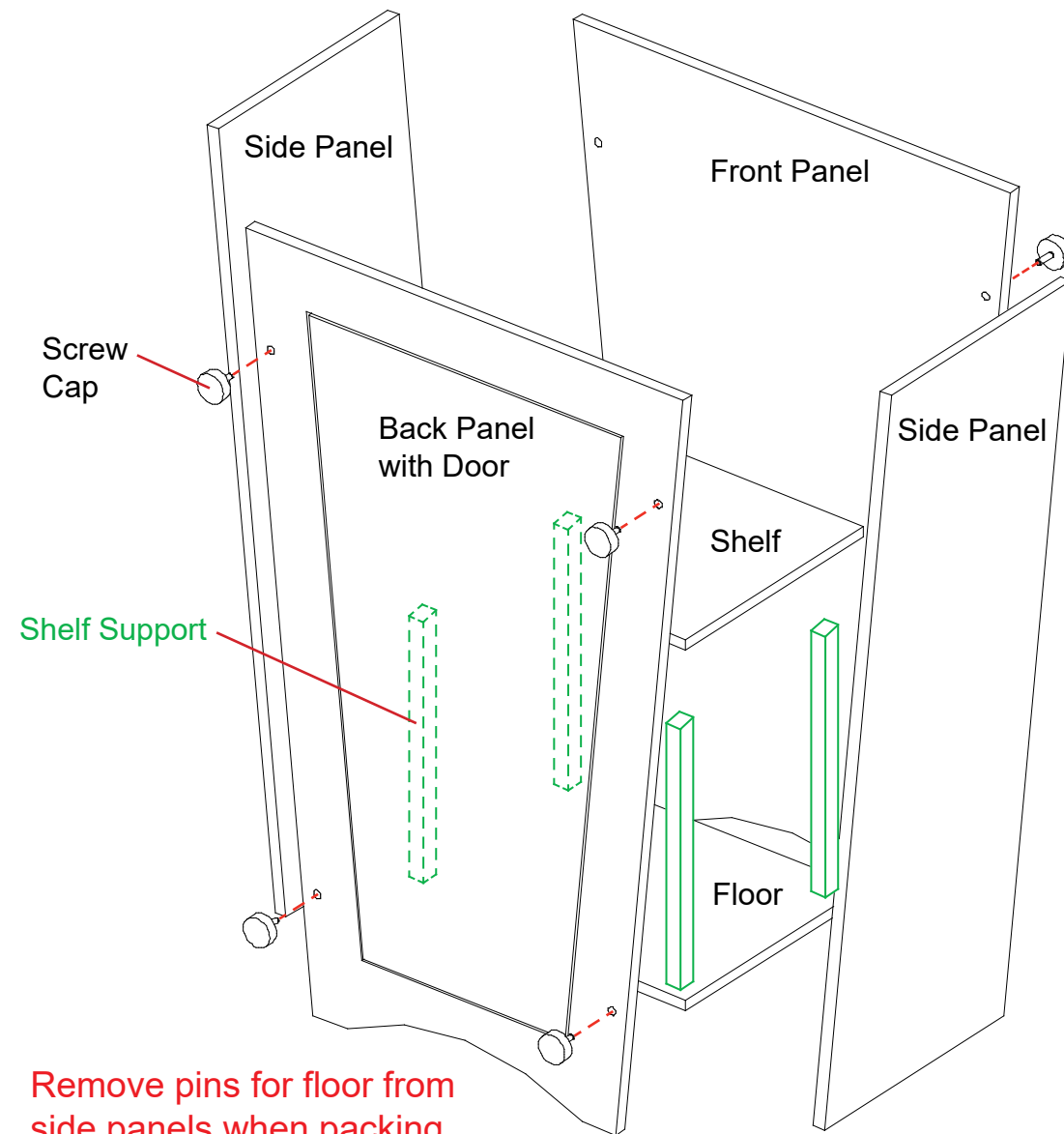

Pedestal Base Assembly

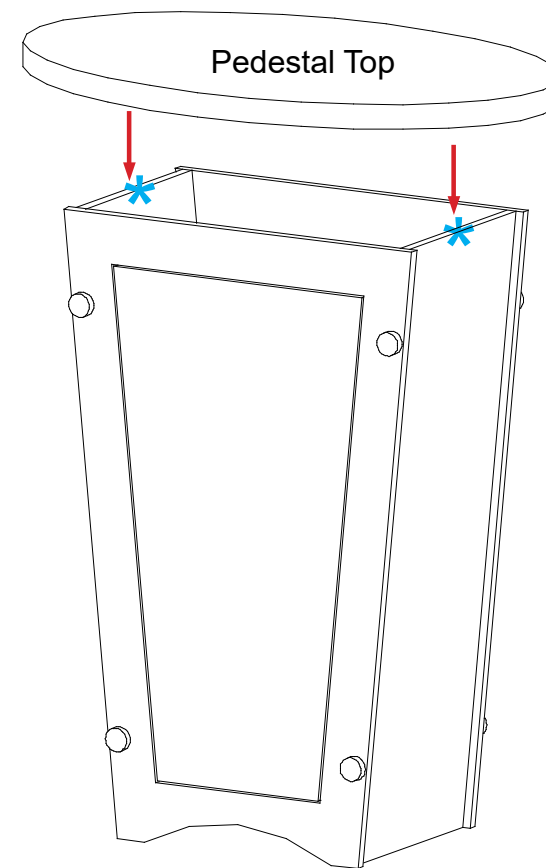

Pedestal Top Attachment

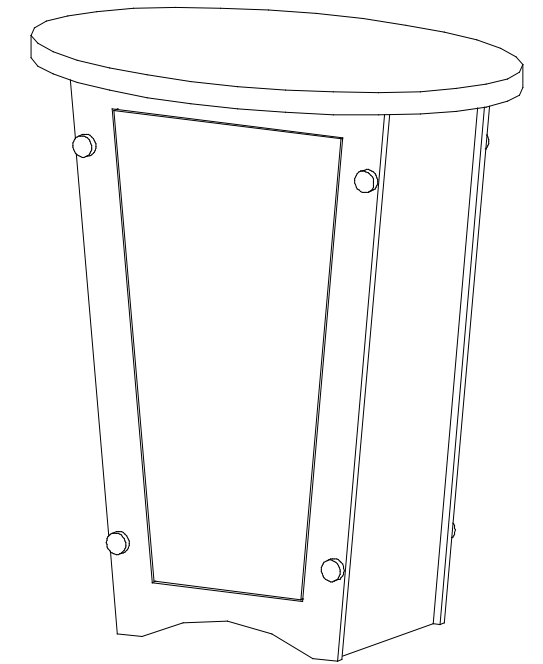

Completed Pedestal Assembly
Qty. 2

